



User Guide

SUMMARY

This guide provides technical specifications and information about monitor features, setting up the monitor, and using the monitor.

© Copyright 2020 HP Development Company, L.P.

HDMI, the HDMI Logo and High-Definition Multimedia Interface are trademarks or registered trademarks of HDMI Licensing LLC. Windows is either a registered trademark or trademark of Microsoft Corporation in the United States and/or other countries. DisplayPort™, the DisplayPort™ logo, and VESA® are trademarks or registered trademarks owned by the Video Electronics Standards Association (VESA) in the United States and other countries.

The information contained herein is subject to change without notice. The only warranties for HP products and services are set forth in the express warranty statements accompanying such products and services. Nothing herein should be construed as constituting an additional warranty. HP shall not be liable for technical or editorial errors or omissions contained herein.

Product notice





This guide describes features that are common to most models. Some features may not be available on your product. To access the latest user guide, go to <http://www.hp.com/support>, and follow the instructions to find your product. Then select **Manuals**.

First Edition: September 2020

Document part number: M21095-001

About this guide

This guide provides technical specifications and information about monitor features, setting up the monitor, and using the software. Depending on the model, your monitor may not have all the features included in this guide.

-
-  **WARNING!** Indicates a hazardous situation that, if not avoided, **could** result in serious injury or death.
 -  **CAUTION:** Indicates a hazardous situation that, if not avoided, **could** result in minor or moderate injury.
 -  **IMPORTANT:** Indicates information considered important but not hazard-related (for example, messages related to property damage). Warns the user that failure to follow a procedure exactly as described could result in loss of data or in damage to hardware or software. Also contains essential information to explain a concept or to complete a task.
 -  **NOTE:** Contains additional information to emphasize or supplement important points of the main text.
 -  **TIP:** Provides helpful hints for completing a task.
-



This product incorporates HDMI technology.

Table of contents

1 Getting started	1
Important safety information	1
More HP resources	1
Preparing to call technical support	2
Getting to know your monitor	2
Features	2
Front components	4
Rear components	4
Locating the serial number and product number	5
Setting up the monitor	5
Attaching the monitor stand	6
Mounting the monitor head	7
Removing the monitor stand	7
Attaching the monitor head to a mounting device	7
Connecting the cables	8
Connecting USB devices	11
Adjusting the monitor	12
Installing a security cable	14
HP watermark and image retention policy	15
2 Using the monitor	16
Downloading software and utilities	16
The Information file	16
The Image Color Matching file	16
Using the OSD menu	16
Changing the Power Mode setting (select products only)	17
Using Auto-Sleep Mode (select products only)	17
Using PiP and PbP (select products only)	18
Using low blue light mode (select products only)	18
DisplayPort multistreaming over DisplayPort (select models only)	18
3 Support and troubleshooting	20
Solving common issues	20
Button lockouts	21

4 Maintaining the monitor	22
Maintenance guidelines	22
Cleaning the monitor	22
Shipping the monitor	23
Appendix A Technical specifications	24
60.5 cm (23.8 in) model specifications	24
61 cm (24 in) model specifications	25
68.6 cm (27 in) model specifications	25
Preset display resolutions	26
60.5 cm (23.8 in) model	26
61 cm (24 in) model	27
68.6 cm (27 in) model	27
60.5 cm (23.8 in) model high-definition video formats	28
61 cm (24 in) model high-definition video formats	28
68.6 cm (27 in) model high-definition video formats	28
Energy saver feature	29
Appendix B Accessibility	30
HP and accessibility	30
Finding the technology tools you need	30
The HP commitment	30
International Association of Accessibility Professionals (IAAP)	31
Finding the best assistive technology	31
Assessing your needs	31
Accessibility for HP products	31
Standards and legislation	32
Standards	32
Mandate 376 – EN 301 549	32
Web Content Accessibility Guidelines (WCAG)	32
Legislation and regulations	33
Useful accessibility resources and links	33
Organizations	33
Educational institutions	33
Other disability resources	34
HP links	34
Contacting support	34

1 Getting started

Read this chapter to learn about safety information and where to find additional HP resources.

Important safety information

A power cord is included with the monitor. If you use another cord, use only a power source and connection appropriate for this monitor. For information about the correct power cord set to use with the monitor, see the *Product Notices* provided in your documentation kit.

 **WARNING!** To reduce the risk of electric shock or damage to the equipment:

- Plug the power cord into an AC outlet that is easily accessible at all times.
- If the power cord has a three-pin attachment plug, plug the cord into a grounded (earthed) three-pin outlet.
- Disconnect power from the computer by unplugging the power cord from the AC outlet. When unplugging the power cord from the AC outlet, grasp the cord by the plug.

For your safety, do not place anything on power cords or cables. Take care to route all cords and cables connected to the monitor so that they cannot be stepped on, pulled, grabbed, or tripped over.

To reduce the risk of serious injury, read the *Safety & Comfort Guide* provided with your user guides. It describes proper workstation setup and proper posture, health, and work habits for computer users. The *Safety & Comfort Guide* also provides important electrical and mechanical safety information. The *Safety & Comfort Guide* is also available on the web at <http://www.hp.com/ergo>.

 **IMPORTANT:** For the protection of the monitor and the computer, connect all power cords for the computer and its peripheral devices (such as a monitor, printer, scanner) to a surge protection device such as a power strip or uninterruptible power supply (UPS). Not all power strips provide surge protection; the power strip must be specifically labeled as having this capability. Use a power strip whose manufacturer offers a damage replacement policy so that you can replace the equipment if surge protection fails.

Use the appropriate and correctly sized furniture designed to properly support your monitor.

 **WARNING!** Monitors that are inappropriately situated on dressers, bookcases, shelves, desks, speakers, chests, or carts could fall over and cause personal injury.

 **WARNING! Stability hazard:** The device might fall, causing serious personal injury or death. To prevent injury, securely attach the monitor to the floor or wall in accordance with the installation instructions.

 **WARNING!** This equipment is not suitable for use in locations where children are likely to be present.

 **NOTE:** This product is suitable for entertainment purposes. Consider placing the monitor in a controlled luminous environment to avoid interference from surrounding light and bright surfaces that might cause disturbing reflections from the screen.

More HP resources

Use this table to locate resources that provide product details, how-to information, and more.

Table 1-1 Additional information

Resource	Contents
Setup Instructions	Overview of monitor setup and features
HP support	<p>For HP support or to resolve a hardware or software problem, go to http://www.hp.com/support, and follow the instructions to find your product.</p> <p>– or –</p> <p>Type support in the taskbar search box, and then select HP Support Assistant. Then select Support.</p> <p>– or –</p> <p>Select the question mark icon in the taskbar search box.</p> <p>Then select Support.</p>

NOTE: Contact customer support to replace the power cord, the AC adapter (select products only), or any other cables that shipped with your monitor.

Preparing to call technical support

Use this information if you have to troubleshoot an issue.

If you cannot solve a problem using [Support and troubleshooting on page 20](#), a call to technical support can provide additional help. Have the following information available when you call.

- Monitor model number
- Monitor serial number
- Purchase date on invoice
- Conditions under which the problem occurred
- Error messages received
- Hardware configuration
- Name and version of the hardware and software that you are using

Getting to know your monitor

Your monitor has top-rated features. This section provides details about your components, where they are located, and how they work.

Features

Depending on the model, your monitor might include the following features:

Display features

- 60.5 cm (23.8 in) diagonal viewable screen area with 1920 × 1080 resolution, plus full-screen support for lower resolutions; includes custom scaling for maximum image size while preserving original aspect ratio
- 61 cm (24 in) diagonal viewable screen area with 1920 × 1200 resolution, plus full-screen support for lower resolutions; includes custom scaling for maximum image size while preserving original aspect ratio

- 68.6 cm (27 in) diagonal viewable screen area with 2560 × 1440 resolution, plus full-screen support for lower resolutions; includes custom scaling for maximum image size while preserving original aspect ratio
- Liquid crystal display (LCD) with active matrix and in-plane switching (IPS)
- Wide color gamut to provide coverage of sRGB color spaces
- Nonglare panel with an LED backlight
- Wide viewing angle to allow viewing from a sitting or standing position, or moving from side to side
- Tilt, swivel, and height adjustment capabilities
- Pivot capability to rotate the monitor head from landscape to portrait orientation
- Dual Picture in Picture (PiP) and Picture beside Picture (PbP) functionality to enable the DisplayPort and HDMI inputs to be viewed in each half of the screen (select products only)
- On-screen display (OSD) adjustments in several languages for easy setup and screen optimization
- Color space presets for sRGB and BT.709
- Energy saver feature to meet requirements for reduced power consumption
- Security cable slot on the rear of the monitor for an optional security cable
- Cable management feature for placement of cables and cords

Connectors

- DisplayPort™ video input (cable included)
- DisplayPort video output (cable included)
- High-Definition Multimedia Interface™ (HDMI) video input
- USB hub with one USB Type-B port (select products only) that connects to the computer (upstream) and four USB ports that connect to USB devices (downstream)
- USB Type-B-to-USB Type-A cable (select products only)
- DisplayPort cable (select products only)
- HDMI cable (select products only)
- Plug and Play capability, if supported by your operating system

Monitor stand

- Removable stand for flexible monitor head mounting solutions
- HP Quick Release 2 device to quickly attach the monitor head to the stand with a simple click, and then remove it with the convenient sliding tab release
- VESA® mounting bracket for attaching the monitor head to a wall-mount device or swing arm
- VESA mounting capability (100 × 100 mm) for attaching the monitor to a swing arm mount
- Support for a mounting bracket to attach the monitor to a workstation



NOTE: For safety and regulatory information, see the *Product Notices* provided in your documentation kit. To access the latest user guide, go to <http://www.hp.com/support>, and follow the instructions to find your product. Then select **Manuals**.

Front components

To identify the power button on the front of the monitor, use this illustration.

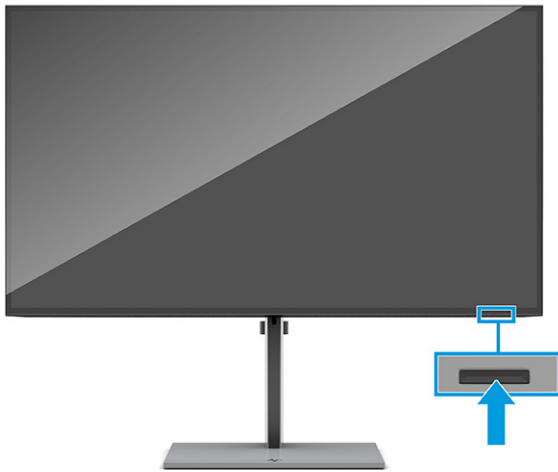

Rear components

To identify the components on the rear of the monitor, use this illustration and table.

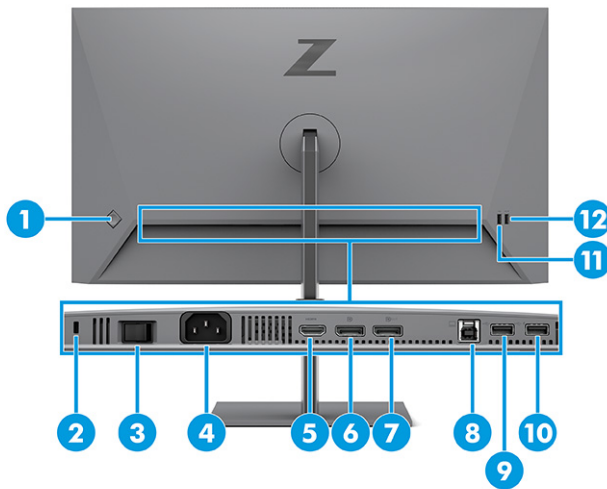

Table 1-2 Rear components and their descriptions

Component	Description
(1) OSD control	Activates the OSD buttons so that the button labels appear on the right side of the screen.
(2) Security cable slot	Connects an optional security cable.
(3) Master power switch	Turns on or off all power to the monitor.
(4) Power connector	Connects the power cord.
(5) HDMI port	Connects the HDMI cable to a source device such as a computer.
(6) DisplayPort connector	Connects the DisplayPort cable to a source device such as a computer.

Table 1-2 Rear components and their descriptions (continued)

Component	Description
(7) DisplayPort connector OUT	Connects the DisplayPort cable from the monitor to a secondary monitor.
(8) USB Type-B port (upstream)	Connects the USB Type-B cable to a source device such as a computer. This port enables the USB Type-A ports to perform their functions.
(9) USB port	Connects a USB cable to a peripheral device, such as a keyboard, mouse, or USB hard drive.
(10) USB port Battery charging 1.2	Connects a USB cable to a peripheral device, such as a keyboard, mouse, or USB hard drive and supports battery charging 1.2.
(11) USB port	Connects a USB cable to a peripheral device, such as a keyboard, mouse, or USB hard drive.
(12) USB port Battery charging 1.2	Connects a USB cable to a peripheral device, such as a keyboard, mouse, or USB hard drive and supports battery charging 1.2.

Locating the serial number and product number

The serial number and product number are located on the rear of the monitor. You might need these numbers when contacting HP about the monitor.

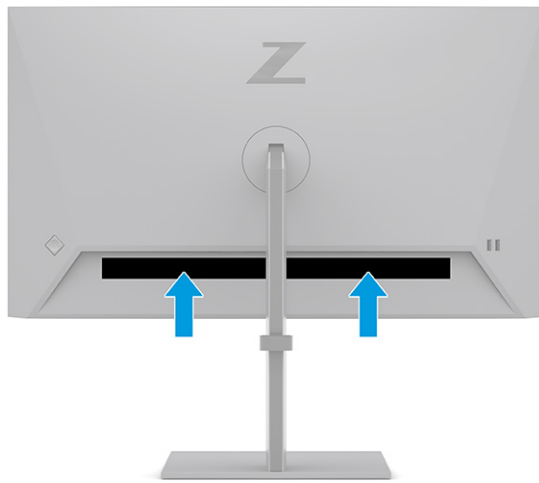

Setting up the monitor

This section describes attaching the monitor stand or wall mount and the options for connecting your monitor to a PC, notebook, gaming console, or similar device.

WARNING! To reduce the risk of serious injury, read the *Safety & Comfort Guide*. It describes proper workstation setup and proper posture, health, and work habits for computer users. The *Safety & Comfort Guide* also provides important electrical and mechanical safety information. The *Safety & Comfort Guide* is available on the web at <http://www.hp.com/ergo>.

IMPORTANT: To prevent damage to the monitor, do not touch the surface of the LCD panel. Pressure on the panel can cause nonuniformity of color or disorientation of the liquid crystals. If this occurs, the screen will not recover to its normal condition.

IMPORTANT: To prevent the screen from getting scratched, defaced, or broken and to prevent damage to the control buttons, position the monitor facedown on a flat surface covered with protective sheet foam or a nonabrasive cloth.

Attaching the monitor stand

Correctly attaching your monitor stand is critical for safe use. This section describes how to safely attach a stand.

TIP: Consider the placement of the monitor, because surrounding light and bright surfaces might cause interfering reflections.

1. With the monitor head facedown in the box, attach the stand to the connector on the back of the monitor.

The latch on the stand clicks when the stand is locked in place.

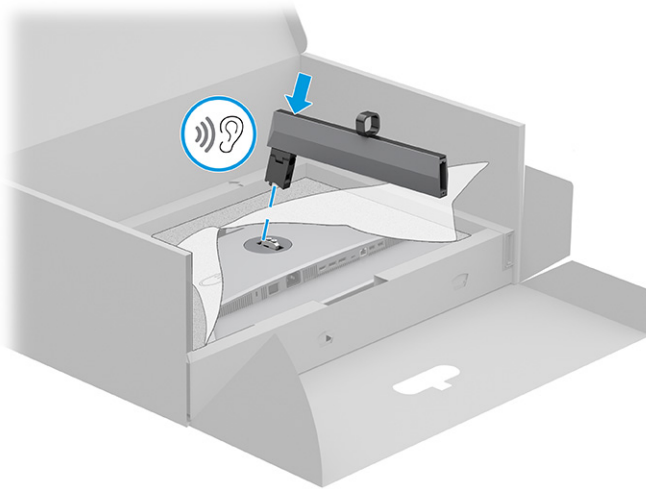

2. Attach the base to the stand (1), and tighten the screw (2).

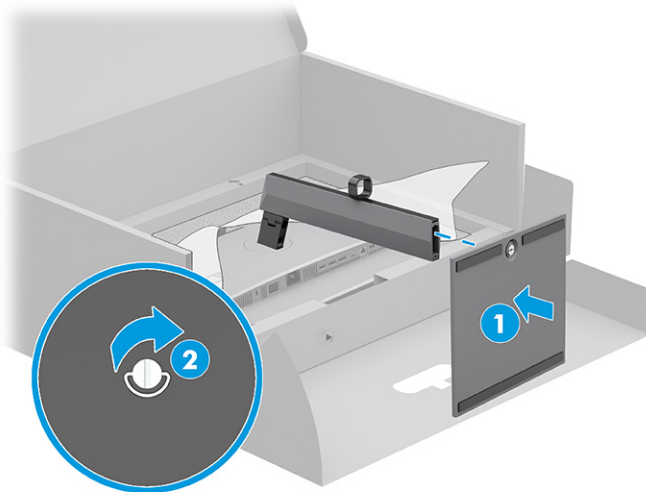

Mounting the monitor head

To attach your monitor to a wall using a swing arm or other mounting fixture, follow the steps in this section to safely and securely connect your monitor.

 **IMPORTANT:** This monitor supports the VESA industry-standard 100 mm mounting holes. To attach a third-party mounting solution to the monitor head, use four 4 mm, 0.7 pitch, and 10 mm long screws. Longer screws might damage the monitor. Be sure that the manufacturer's mounting solution is compliant with the VESA standard and is rated to support the weight of the monitor head. For best performance, use the power and video cables provided with the monitor.

 **NOTE:** This apparatus is intended to be supported by a UL-listed or CSA-listed wall-mount bracket.

Removing the monitor stand

If you decide to use a wall mount instead of the monitor stand that you attached, first remove the stand.

 **IMPORTANT:** Before you disassemble the monitor, be sure that the monitor is turned off and all cables are disconnected.

IMPORTANT: To position and stabilize the monitor, HP recommends that two people perform these procedures.

1. Disconnect and remove all cables from the monitor.
2. Position the monitor facedown on a flat surface covered by protective sheet made of foam or a clean, dry cloth.
3. Push up the latch near the bottom center of the stand's mounting connector **(1)**.
4. Lift the stand up and away from the monitor **(2)**.

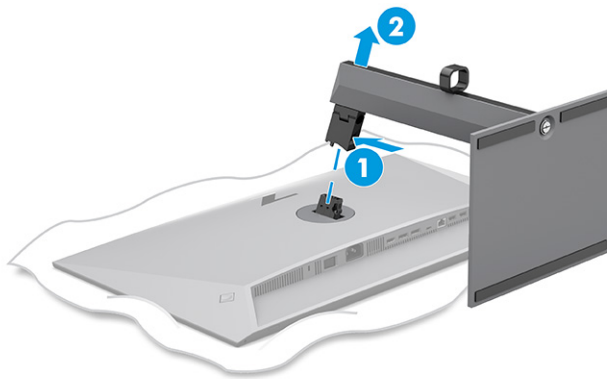

Attaching the monitor head to a mounting device

You might need additional tools such as a screwdriver (purchased separately) when you attach a mounting device. To avoid damage to your monitor, follow these instructions.

1. Remove the two screws from the stand mount on the back of the monitor head **(1)**.
2. Lift the stand mount off of the monitor head **(2)**.

3. Align the VESA mounting plate with the two VESA screw holes **(3)**, and then tighten the screws **(4)**.

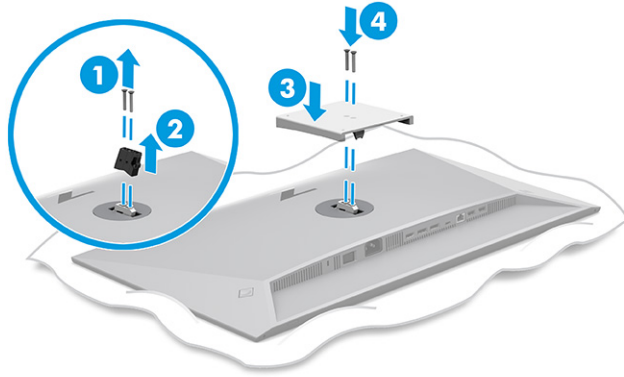

4. To attach the monitor head to a swing arm or other mounting device, insert four mounting screws through the holes on the mounting device and into the VESA screw holes on the back of the monitor head.

 **IMPORTANT:** If these instructions do not apply to your device, then follow the mounting device manufacturer's instructions when mounting the monitor to a wall or swing arm.

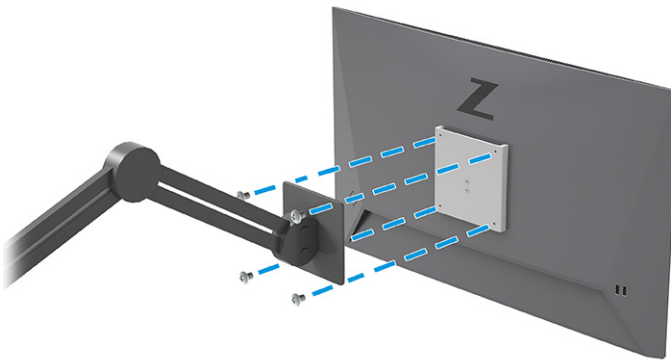

Connecting the cables

In addition to details about how to connect a cable, this section contains information about how your monitor functions when you connect certain cables.

 **NOTE:** Depending on the model, the monitor might be capable of supporting HDMI or DisplayPort inputs. The video mode is determined by the video cable used. The monitor automatically determines which inputs have valid video signals. You can select the inputs through the OSD menu. The monitor ships with select cables. Not all cables shown in this section are included with the monitor.

1. Place the monitor in a convenient, well-ventilated location near the computer.

2. Route the signal cable and power cable through the cable routing fixture on the monitor stand.

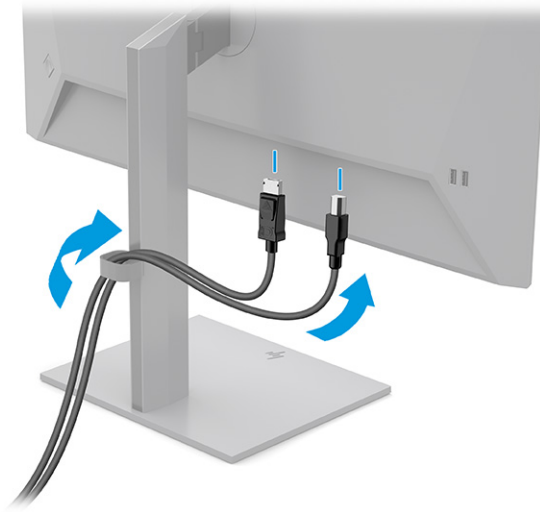

3. Connect a video cable.



NOTE: The monitor automatically determines which inputs have valid video signals. To select any input, open the OSD menu and select **Input**.

- Connect one end of a DisplayPort cable to the DisplayPort connector on the rear of the monitor and the other end to the DisplayPort connector on the source device.

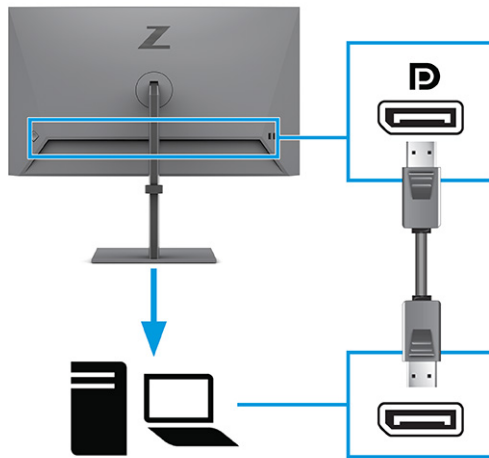

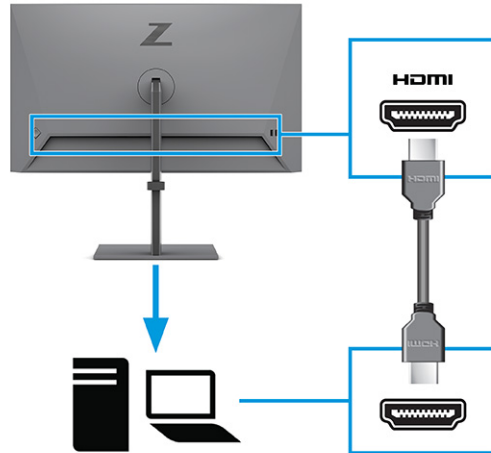

- Connect one end of an HDMI cable to the HDMI port on the rear of the monitor and the other end to the HDMI port on the source device.

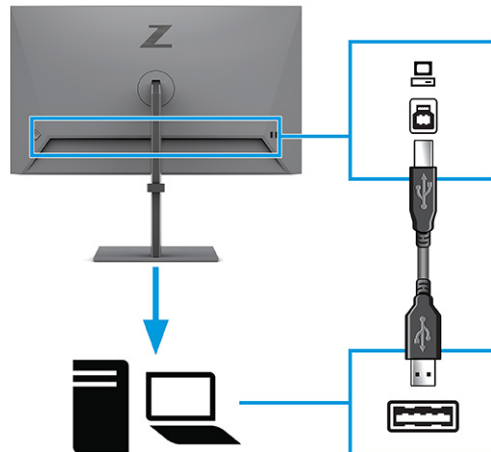

4. Connect a USB cable.

- Connect one end of a USB Type-A to USB Type-B cable to the USB Type-B port on the rear of the monitor and the other end to a USB port on the source device.



 **NOTE:** You must connect a USB Type-B cable from the source device (computer or laptop) to the rear of the monitor to enable the USB Type-A ports on the monitor. For more information, see [Connecting USB devices on page 11](#).

5. Connect one end of the power cord to the power connector on the rear of the monitor and the other end to a grounded AC outlet.

⚠ WARNING! To reduce the risk of electric shock or damage to the equipment:

Do not disable the power cord grounding plug. The grounding plug is an important safety feature.

Plug the power cord into a grounded (earthed) AC outlet that is easily accessible at all times.

Disconnect power from the equipment by unplugging the power cord from the AC outlet.

For your safety, do not place anything on power cords or cables. Arrange them so that no one can accidentally step on or trip over them. Do not pull on a cord or cable. When unplugging the power cord from the AC outlet, grasp the cord by the plug.

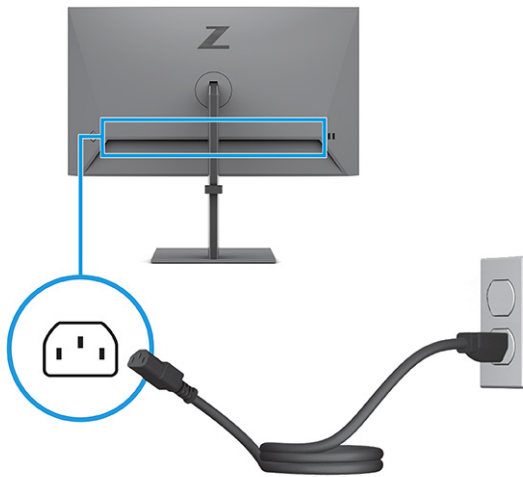

Connecting USB devices

Use USB ports to connect devices such as a digital camera, USB keyboard, or USB mouse. There are four USB ports on the monitor to connect to a device (downstream): two USB Type-A ports and two USB Type-A ports with battery charging 1.2.

📝 NOTE: You must connect a USB Type-B cable from the source device (computer) to the rear of the monitor to enable the USB Type-A ports to serve as a USB hub for a mouse, keyboards, phones, external hard drives, and practically anything that is USB-connected and can accept 5 V.

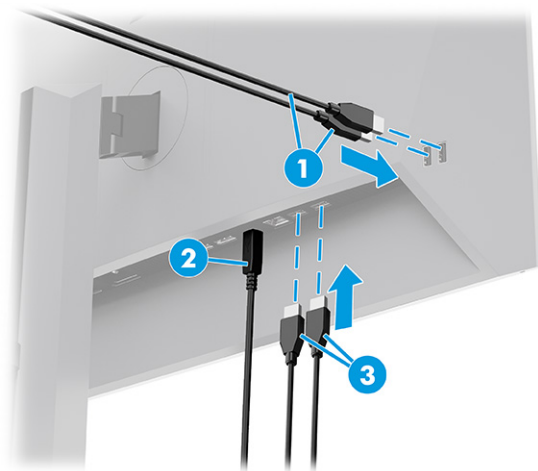

Table 1-3 USB port locations

USB Ports	
(1)	USB Type-A ports
(2)	USB Type-B port from computer
(3)	USB Type-A ports

Adjusting the monitor

To support an ergonomic work space, your monitor offers the adjustment options outlined in this section.

⚠ WARNING! To reduce the risk of serious injury, read the *Safety & Comfort Guide*. It describes proper workstation setup and proper posture, health, and work habits for computer users. The *Safety & Comfort Guide* also provides important electrical and mechanical safety information. The *Safety & Comfort Guide* is available on the web at <http://www.hp.com/ergo>.

1. Tilt the monitor head forward or backward to set it to a comfortable eye level.

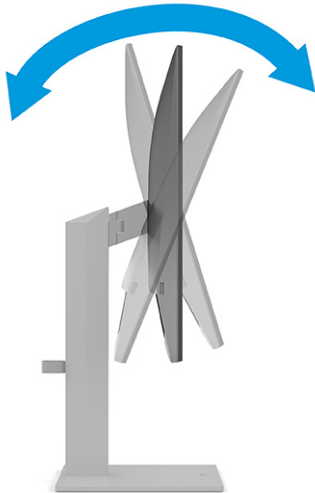

2. Adjust the monitor's height to a comfortable position for your individual workstation. The monitor's top bezel edge should not exceed a height that is parallel to your eye height. A monitor that is positioned low and reclined might be more comfortable for users with corrective lenses. Reposition your monitor as you adjust your working posture throughout the work day.



3. Swivel the monitor head to the left or right for the best viewing angle.

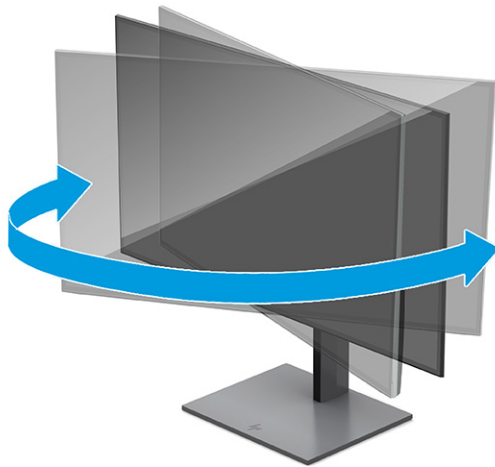



4. You can pivot the monitor head from landscape to portrait orientation viewing to adapt to your application.
 - a. Adjust the monitor to full height position and tilt the monitor back to full tilt position **(1)**.

- b. Pivot the monitor clockwise 90° from landscape to portrait orientation (2).

 **IMPORTANT:** If the monitor is not in full height and full tilt position when pivoting, the bottom right corner of the monitor panel will come in contact with the base and potentially cause damage to the monitor.

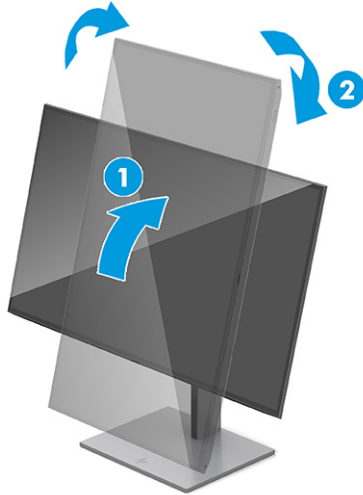
If you are adding an optional speaker bar to the monitor, install it after pivoting the monitor. The speaker bar will come in contact with the base when the monitor pivots and potentially cause damage to the monitor or speaker bar.



 **NOTE:** Use the operating system's display settings to rotate the image on the screen from portrait to landscape. To rotate the OSD from portrait to landscape, open the OSD menu and select **Menu**, select **Menu Rotation**, and then select **Portrait**.

Installing a security cable

As a security measure, you can secure the monitor to a fixed object with an optional security cable available from HP. Use the key provided to attach and remove the lock.



HP watermark and image retention policy

Some monitors are designed with In-Plane Switching (IPS) display technology, which provides ultra-wide viewing angles and advanced image quality. Though suitable for many applications, this panel technology is not suitable for static, stationary, or fixed images for long periods of time, unless you use screen savers.

Applications with static images can include camera surveillance, video games, marketing logos, and templates. Static images can cause image retention damage that could look like stains or watermarks on the monitor's screen.

Image retention damage on monitors that are in use 24 hours per day is not covered under the HP warranty. To avoid image retention damage, always turn off the monitor when it is not in use, or use the power management setting, if supported on your computer, to turn off the monitor when the computer is idle.

2 Using the monitor

This chapter describes how to use your monitor and its features, including software and utilities, the OSD menu, and power modes.

Downloading software and utilities

You can download and install these files from HP Support.

- INF (Information) file
- ICM (Image Color Matching) files

To download the files:

1. Go to <http://www.hp.com/support>.
2. Select **Software and Drivers**.
3. Select your product type.
4. Enter your HP monitor model in the search field and follow the on-screen instructions.

The Information file

The INF file defines monitor resources used by Windows® operating systems to ensure monitor compatibility with the computer's graphics adapter.

This monitor is Plug and Play compatible, and the monitor will work correctly without installing the INF file. Monitor Plug and Play compatibility requires that the computer's graphics card is VESA DDC2 compliant and that the monitor connects directly to the graphics card. Plug and Play does not work through separate BNC-type connectors or through distribution buffers, boxes, or both.

The Image Color Matching file

The ICM files are data files that are used in conjunction with graphics programs to provide consistent color matching from monitor screen to printer, or from scanner to monitor screen. These files are activated from within graphics programs that support this feature.



NOTE: The ICM color profile is written in accordance with the International Color Consortium (ICC) Profile Format specification.

Using the OSD menu

You can adjust your HP monitor to suit your tastes. Use the OSD menu to customize the viewing features of your monitor.

To access the OSD menu and make adjustments:

1. If the monitor is not already on, press the power button to turn on the monitor.
2. Press the center of the OSD controller.
3. Move the controller up, down, left, or right to navigate menu choices. Press the center of the controller to make a selection.

The following table lists possible menu selections in the OSD main menu. It includes descriptions for each setting and its impacts on your monitor's appearance or performance.

Table 2-1 OSD menu options and descriptions for using a button or a controller

Main menu	Description
Brightness+	Adjusts the brightness level of the screen. The factory default is 65 or 75 depending on your model.
Color	Selects and adjusts the screen color and provides a variety of color presets that configure the monitor for different viewing situations.
Image	Adjusts the screen image, including response time, sharpness, and image scaling.
Input	Selects the video input signal (DisplayPort or HDMI).
Power	Adjusts the power settings.
Menu	Adjusts the OSD menu.
Management	Adjusts the DDC/CI settings and returns all OSD menu settings to the factory default settings.
Information	Provides information about the monitor such as optimal display mode, power mode, and serial number.
Exit	Exits the OSD menu screen.

Changing the Power Mode setting (select products only)

This section describes how to activate Performance mode. Certain features on your monitor might require Performance mode to be active.

When in sleep mode, to comply with international power standards, the monitor default setting is Power Saver mode.

If your monitor supports Performance mode, then to keep the USB ports enabled when the monitor is in Auto-Sleep Mode, change the Power Mode setting from **Power Saver** to **Performance**.



NOTE: If you are connecting a computer that is not battery powered, the Power Mode setting must be changed to Performance mode.

To change the power mode setting:

1. Press the center of the OSD controller.
2. Select **Power**, select **Power Mode**, and then select **Performance**.
3. Select **Back** and close the OSD.

Using Auto-Sleep Mode (select products only)

Your monitor has an energy-saving feature called Auto-Sleep Mode, a reduced power state. This section describes how to activate or adjust Auto-Sleep Mode on your monitor.

When Auto-Sleep Mode is enabled (enabled by default), the monitor enters a reduced power state when the computer signals low power mode (absence of either horizontal or vertical sync signal).

Upon entering this reduced power state (Auto-Sleep mode), the monitor screen is blanked, the backlight turns off, and the power light turns amber. The monitor draws less than 0.5 W of power when in this reduced power state. The monitor wakes from Auto-Sleep mode when the computer sends an active signal to the monitor (for example, when you activate the mouse or keyboard).

To disable Auto-Sleep Mode in the OSD:

1. Press the center of the OSD controller to open the OSD.
2. In the OSD, select **Power**.
3. Select **Auto-Sleep Mode**, and then select **Off**.

Using PiP and PbP (select products only)

The monitor supports both Picture in Picture (PiP), where one source is overlaid on another, and Picture beside Picture (PbP), where one source is positioned adjacent to another either horizontally (for landscape orientation) or vertically (for portrait orientation). Two full HD (FHD) images can be displayed in the PiP mode.

To use PiP or PbP:

1. Connect a secondary input source to the monitor.
2. Press the center of the OSD controller to open the OSD.
3. In the OSD, select **Image**, select **PiP**, and then select **Enable PiP**.

The monitor scans the secondary inputs for a valid signal input and uses that input for the PiP or PbP picture.

4. If you want to change the PiP or PbP input, select **Image**, select **PiP**, and then select **Assign Inputs**.
5. If you want to change the size of the PiP, select **PiP Size** in the OSD, and then select the size that you want.
6. If you want to adjust the position of the PiP, select **PiP Position** in the OSD, and then select the position that you want.

Using low blue light mode (select products only)

Decreasing the blue light emitted by the monitor reduces the blue light exposure to your eyes. This monitor uses a low blue light panel in default setting mode.

In the default setting mode, this monitor's low blue light panel is certified by TÜV to reduce blue light output and create a more relaxing and less stimulating image while you read content on the screen.

DisplayPort multistreaming over DisplayPort (select models only)

If you are using DisplayPort as the primary video input source, you can multistream to other DisplayPort monitors connected in a daisy-chain configuration. You can connect up to four monitors in this configuration if the graphics card in your computer supports this configuration.

The number of monitors you can connect through DisplayPort multistreaming depends on a number of factors, including the resolutions and scan rates used for each monitor and the capabilities of your GPU or embedded graphics system. If you have purchased a new graphics card for your computer, check the manual that came with your graphics card for further information about its capabilities.

To multistream:

1. Be sure that DisplayPort is your primary video input.
2. Add a second monitor by connecting a DisplayPort cable between the DisplayPort OUT connector on the primary monitor and the DisplayPort connector on a secondary monitor.

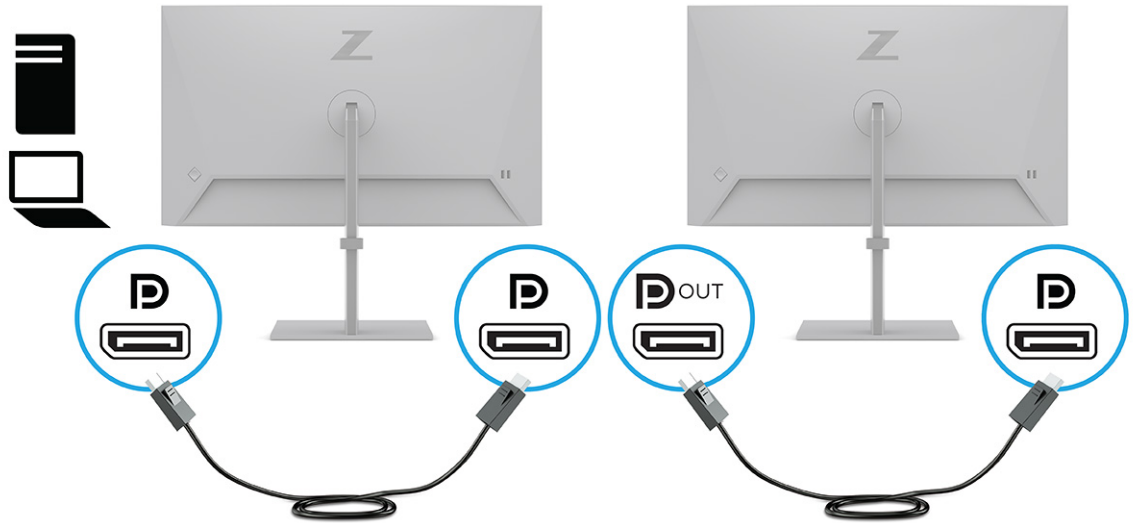

NOTE: You can connect up to four additional monitors. All but the final monitor in the chain must support DisplayPort multistreaming. For example when daisy-chaining four monitors, three of the four daisy-chained monitors need to have DisplayPort and DisplayPort OUT connectors. The last monitor in the chain needs only a DisplayPort connector.

3. Set a connected monitor to display the same image as the primary monitor or a different image.
4. Connect the DisplayPort cable from the DisplayPort OUT connector of one monitor to the DisplayPort connector of the next monitor.

3 Support and troubleshooting

If your monitor is not working as expected, you might be able to resolve the issue by following the instructions in this section.

Solving common issues

The following table lists possible issues, the possible cause of each issue, and the recommended solutions.

Table 3-1 Common issues and solutions

Issues	Possible cause	Solution
Screen is blank or video is flashing.	Power cord is disconnected.	Connect the power cord.
	Monitor is off.	Press the monitor power button. NOTE: If pressing the power button has no effect, press and hold the power button for 10 seconds to disable the Power Button Lockout feature.
	Master power switch is set to off.	Set the master power switch on the rear of the monitor to the On position.
	Video cable is improperly connected.	Connect the video cable properly. For more information, see Connecting the cables on page 8 .
	System is in Auto-Sleep Mode.	Press any key on the keyboard or move the mouse to inactivate the screen blanking utility.
	Video card is incompatible.	Open the OSD menu and select the Input menu. Set Auto-Switch Input to Off and manually select the input. or Replace the video card or connect the video cable to one of the computer's on-board video sources.
Image appears blurred, indistinct, or too dark.	Brightness setting is too low.	Open the OSD menu, and select Brightness to adjust the brightness scale as needed.
"Check Video Cable" is displayed on the screen.	Monitor video cable is disconnected.	Connect the appropriate video signal cable between the computer and monitor. Be sure that the computer power is off while connecting the video cable.
"Input Signal Out of Range" is displayed on screen.	Video resolution and/or refresh rate are set higher than the monitor supports.	Change the settings to a supported setting (see Preset display resolutions on page 26).
The monitor does not enter into a low-power sleep state.	The monitor's power saving control is disabled.	Open the OSD menu and select Power , select Auto-Sleep Mode , and then set auto-sleep to On .
"OSD Lockout" is displayed.	The monitor's OSD Lockout function is enabled.	Press and hold the center of the OSD controller for 10 seconds to disable the OSD Lockout function.
"Power Button Lockout" is displayed.	The monitor's Power Button Lockout feature is enabled.	Press and hold the Power button for 10 seconds to unlock the power button function.

Button lockouts

The button lockout function is available only when the monitor is on, an active signal is displayed, and the OSD menu is closed. Pressing and holding down the center of the OSD controller for 10 seconds disables that button. You can re-enable the button by holding it down again for 10 seconds.

4 Maintaining the monitor

Properly maintained, your monitor can run for many years. These instructions provide steps you can perform to keep your monitor in the best condition.

Maintenance guidelines

Follow these instructions to enhance the performance and extend the life of the monitor.

- Do not open the monitor cabinet or attempt to service this product yourself. Adjust only those controls that are covered in the operating instructions. If the monitor is not operating properly or has been dropped or damaged, contact an authorized HP dealer, reseller, or service provider.
- Use only a power source and connection appropriate for this monitor, as indicated on the label or back plate of the monitor.
- Be sure that the total ampere rating of the products connected to the outlet does not exceed the current rating of the AC outlet and that the total ampere rating of the products connected to the cord does not exceed the rating of the cord. Look on the power label to determine the ampere rating (AMPS or A) for each device.
- Install the monitor near an outlet that you can easily reach. Disconnect the monitor by grasping the plug firmly and pulling it from the outlet. Never disconnect the monitor by pulling the cord.
- Turn the monitor off when it is not in use, and use a screen saver program. Doing this can substantially increase the life expectancy of the monitor.



NOTE: A burned-in image on the monitor is not covered under the HP warranty.

- Never block the slots and openings of the cabinet or push objects into them. These openings provide ventilation.
- Do not drop the monitor or place it on an unstable surface.
- Do not allow anything to rest on the power cord. Do not walk on the cord.
- Keep the monitor in a well-ventilated area, away from excessive light, heat, or moisture.

Cleaning the monitor

Use these instructions to clean your monitor when necessary.

1. Turn off the monitor and unplug the power cord from the AC outlet.
2. Disconnect any external devices.
3. Dust the monitor by wiping the screen and the cabinet with a soft, clean antistatic cloth.
4. For more difficult cleaning situations, use a 50/50 mix of water and isopropyl alcohol.



IMPORTANT: Do not use cleaners that contain petroleum-based materials such as benzene, thinner, or any volatile substance to clean the monitor screen or cabinet. These chemicals might damage the monitor.

IMPORTANT: Spray the cleaner onto a cloth and use the damp cloth to gently wipe the screen surface. Never spray the cleaner directly on the screen surface. It can run behind the bezel and damage the electronics. The cloth should be moist, but not wet. Water dripping into the ventilation openings or other points of entry can cause damage to the monitor. Allow the monitor to air-dry before use.

5. After you remove the dirt and debris, you can also clean the surfaces with a disinfectant. The World Health Organization (WHO) recommends cleaning surfaces, followed by disinfection, as a best practice for preventing the spread of viral respiratory illnesses and harmful bacteria. A disinfectant that is within HP's cleaning guidelines is an alcohol solution consisting of 70% isopropyl alcohol and 30% water. This solution is also known as rubbing alcohol and is sold in most stores.

Shipping the monitor

Keep the original packing box in a storage area. You might need it later if you ship the monitor or move.

A Technical specifications

This section contains technical specifications for the physical aspects of your monitor, such as the weight and viewing dimensions, as well as required environmental operating conditions and power source ranges.

All specifications represent the typical specifications provided by HP component manufacturers; actual performance can vary either higher or lower.



NOTE: For the latest specifications or additional specifications for this product, go to <http://www.hp.com/go/quickspecs/> and search for your specific monitor model to find the model-specific QuickSpecs.

60.5 cm (23.8 in) model specifications

This section provides specifications for your monitor.

Table A-1 Technical specifications

Specification	Measurement	
Display	60.5 cm	23.8 in
Type	IPS	
Viewable image size	60.5 cm diagonal	23.8 in diagonal
Maximum weight (unpacked)	4.7 kg	10.4 lbs
Dimensions (include base)		
Height (highest position)	48.93 cm	19.26 in
Height (lowest position)	33.93	13.36 in
Depth	19.5 cm	7.68 in
Width	53.84 cm	21.2 in
Tilt	-5° to 20°	
Swivel	± 45°	
Pivot	± 90°	
Environmental requirements temperature		
Operating temperature	5°C to 35°C	41°F to 95°F
Storage temperature	-34°C to 60°C	-29°F to 140°F
Storage humidity	5% to 95% (noncondensing)	
Power source	100 V ac to 240 V ac 50/60 Hz	
Input terminal	One HDMI port, one DisplayPort connector	

61 cm (24 in) model specifications

This section provides specifications for your monitor.

Table A-2 Technical specifications

Specification	Measurement	
Display	61 cm	24 in
Type	IPS	
Viewable image size	61 cm diagonal	24 in diagonal
Maximum weight (unpacked)	5.3 kg	11.7 lbs
Dimensions (include base)		
Height (highest position)	52.14 cm	20.53 in
Height (lowest position)	37.14 cm	14.62 in
Depth	19.5 cm	7.68 in
Width	53.17 cm	20.93 in
Tilt	-5° to 20°	
Swivel	± 45°	
Pivot	± 90°	
Environmental requirements temperature		
Operating temperature	5°C to 35°C	41°F to 95°F
Storage temperature	-34°C to 60°C	-29°F to 140°F
Storage humidity	5% to 95% (noncondensing)	
Power source	100 V ac to 240 V ac 50/60 Hz	
Input terminal	One HDMI port, one DisplayPort connector	

68.6 cm (27 in) model specifications

This section provides specifications for your monitor.

Table A-3 Technical specifications

Specification	Measurement	
Display, wide-screen	68.6 cm	27 in
Type	IPS	
Viewable image size	68.6 cm diagonal	27 in diagonal
Maximum weight (unpacked)	5.8 kg	12.8 lbs
Dimensions (include base)		
Height (highest position)	53.04 cm	20.88 in
Height (lowest position)	38.04 cm	14.98 in

Table A-3 Technical specifications (continued)

Specification	Measurement	
Depth	20.5 cm	8.07 in
Width	61.23 cm	24.11 in
Tilt	-5° to 20°	
Swivel	± 45°	
Pivot	± 90°	
Environmental requirements temperature		
Operating temperature	5°C to 35°C	41°F to 95°F
Storage temperature	-34°C to 60°C	-29°F to 140°F
Storage humidity	5% to 95% (noncondensing)	
Power source	100 V ac to 240 V ac 50/60 Hz	
Input terminal	One HDMI port, one DisplayPort connector	

Preset display resolutions

The following display resolutions are the most commonly used modes and are set as factory defaults. The monitor automatically recognizes these preset modes, and they will appear properly sized and centered on the screen.

60.5 cm (23.8 in) model

This section provides preset display resolutions and preset timing resolutions.

Table A-4 Preset display resolutions

Preset	Pixel format	Horz freq (kHz)	Vert freq (Hz)
1	640 × 480	31.469	59.940
2	800 × 600	37.879	60.317
3	1024 × 768	48.363	60.004
4	1280 × 720	45.000	60.000
5	1280 × 800	49.702	59.810
6	1280 × 1024	63.981	60.020
7	1440 × 900	55.935	59.887
8	1600 × 900	60.000	60.000
9	1680 × 1050	65.290	59.954
10	1920 × 1080	67.500	60.000

61 cm (24 in) model

This section provides preset display resolutions and preset timing resolutions.

Table A-5 Preset display resolutions

Preset	Pixel format	Horz freq (kHz)	Vert freq (Hz)
1	640 × 480	31.469	59.940
2	800 × 600	37.879	60.317
3	1024 × 768	48.363	60.004
4	1280 × 720	45.000	60.000
5	1280 × 800	49.702	59.810
6	1280 × 1024	63.981	60.020
7	1440 × 900	55.935	59.887
8	1600 × 900	60.000	60.000
9	1600 × 1200	75.000	60.000
10	1680 × 1050	65.290	59.954
11	1920 × 1080	67.500	60.000
12	1920 × 1200	74.038	59.950
13	1920 × 1200	74.556	59.885

68.6 cm (27 in) model

This section provides preset display resolutions and preset timing resolutions.

Table A-6 Preset display resolutions

Preset	Pixel format	Horz freq (kHz)	Vert freq (Hz)
1	640 × 480	31.47	60
2	800 × 600	37.88	60
3	1024 × 768	48.3	60
4	1280 × 720	45	60
5	1280 × 1024	64	60
6	1440 × 900	56	60
7	1600 × 900	60	60
8	1600 × 1200	75	60
9	1680 × 1050	65.3	60
10	1920 × 1080	67.5	60
11	1920 × 1200	74.6	60
12	2560 × 1440	88.8	60

60.5 cm (23.8 in) model high-definition video formats

This section provides high-definition video formats.

Table A-7 High-definition video formats

Preset	Timing name	Pixel format	Horz freq (kHz)	Vert freq (Hz)
1	480p	720 × 480	31.469	59.94
2	576p	720 × 576	31.25	50
3	720p50	1280 × 720	37.5	50
4	720p60	1280 × 720	45	60
5	1080p50	1920 × 1080	56.25	50
6	1080p60	1920 × 1080	67.5	60

61 cm (24 in) model high-definition video formats

This section provides high-definition video formats.

Table A-8 High-definition video formats

Preset	Timing name	Pixel format	Horz freq (kHz)	Vert freq (Hz)
1	480p	720 × 480	31.469	59.94
2	576p	720 × 576	31.25	50
3	720p50	1280 × 720	37.5	50
4	720p60	1280 × 720	45	60
5	1080p50	1920 × 1080	56.25	50
6	1080p60	1920 × 1080	67.5	60

68.6 cm (27 in) model high-definition video formats

This section provides high-definition video formats.

Table A-9 High-definition video formats

Preset	Timing name	Pixel format	Horz freq (kHz)	Vert freq (Hz)
1	480i	720 × 480	15.734	60
2	480p	720 × 480	31.469	60
3	576i	720 × 576	15.625	50
4	576p	720 × 576	31.250	50
5	720p50	1280 × 720	37.500	50
6	720p60	1280 × 720	45.000	60
7	1080i60	1920 × 1080	33.750	60

Table A-9 High-definition video formats (continued)

Preset	Timing name	Pixel format	Horz freq (kHz)	Vert freq (Hz)
8	1080p60	1920 × 1080	67.500	60
9	1080i50	1920 × 1080	28.125	50
10	1080p50	1920 × 1080	56.250	50

Energy saver feature

This monitor supports a reduced power state (power saver mode).

The reduced power state is initiated if the monitor detects the absence of either the horizontal sync signal or the vertical sync signal. Upon detecting the absence of these signals, the monitor screen is blank, the backlight is turned off, and the power light turns amber. In the reduced power state, the monitor uses < 0.5 W of power. There is a brief warm-up period before the monitor returns to its normal operating state.

See the computer manual for instructions on setting the energy saver mode (sometimes called “power management feature”).



NOTE: This power saver feature works only when the monitor is connected to a computer that has energy-saver features.

By selecting the settings in the monitor Sleep Timer utility, you can also program the monitor to initiate the reduced power state at a predetermined time. When the monitor Sleep Timer utility initiates the reduced power state, the power light blinks amber.

B Accessibility

HP's goal is to design, produce, and market products, services, and information that everyone everywhere can use, either on a stand-alone basis or with appropriate third-party assistive technology (AT) devices or applications.

HP and accessibility

Because HP works to weave diversity, inclusion, and work/life into the fabric of the company, it is reflected in everything HP does. HP strives to create an inclusive environment focused on connecting people to the power of technology throughout the world.

Finding the technology tools you need

Technology can unleash your human potential. Assistive technology removes barriers and helps you create independence at home, at work, and in the community. Assistive technology helps increase, maintain, and improve the functional capabilities of electronic and information technology.

For more information, see [Finding the best assistive technology on page 31](#).

The HP commitment

HP is committed to providing products and services that are accessible for people with disabilities. This commitment supports the company's diversity objectives and helps ensure that the benefits of technology are available to all.

The HP accessibility goal is to design, produce, and market products and services that can be effectively used by everyone, including people with disabilities, either on a stand-alone basis or with appropriate assistive devices.

To achieve that goal, this Accessibility Policy establishes seven key objectives to guide HP actions. All HP managers and employees are expected to support these objectives and their implementation in accordance with their roles and responsibilities:

- Raise the level of awareness of accessibility issues within HP, and provide employees with the training they need to design, produce, market, and deliver accessible products and services.
- Develop accessibility guidelines for products and services, and hold product development groups accountable for implementing these guidelines where competitively, technically, and economically feasible.
- Involve people with disabilities in the development of accessibility guidelines and in the design and testing of products and services.
- Document accessibility features, and make information about HP products and services publicly available in an accessible form.
- Establish relationships with leading assistive technology and solution providers.
- Support internal and external research and development that improves assistive technology relevant to HP products and services.
- Support and contribute to industry standards and guidelines for accessibility.

International Association of Accessibility Professionals (IAAP)

IAAP is a not-for-profit association focused on advancing the accessibility profession through networking, education, and certification. The objective is to help accessibility professionals develop and advance their careers and to better enable organizations to integrate accessibility into their products and infrastructure.

As a founding member, HP joined to participate with other organizations to advance the field of accessibility. This commitment supports HP's accessibility goal of designing, producing, and marketing products and services that people with disabilities can effectively use.

IAAP will make the profession strong by globally connecting individuals, students, and organizations to learn from one another. If you are interested in learning more, go to <http://www.accessibilityassociation.org> to join the online community, sign up for newsletters, and learn about membership options.

Finding the best assistive technology

Everyone, including people with disabilities or age-related limitations, should be able to communicate, express themselves, and connect with the world using technology. HP is committed to increasing accessibility awareness within HP and with our customers and partners.

Whether it's large fonts that are easy on the eyes, voice recognition that lets you give your hands a rest, or any other assistive technology to help with your specific situation—a variety of assistive technologies make HP products easier to use. How do you choose?

Assessing your needs

Technology can unleash your potential. Assistive technology removes barriers and helps you create independence at home, at work, and in the community. Assistive technology (AT) helps increase, maintain, and improve the functional capabilities of electronic and information technology.

You can choose from many AT products. Your AT assessment should allow you to evaluate several products, answer your questions, and facilitate your selection of the best solution for your situation. You will find that professionals qualified to do AT assessments come from many fields, including those licensed or certified in physical therapy, occupational therapy, speech/language pathology, and other areas of expertise. Others, while not certified or licensed, can also provide evaluation information. You will want to ask about the individual's experience, expertise, and fees to determine if they are appropriate for your needs.

Accessibility for HP products

These links provide information about accessibility features and assistive technology, if applicable, included in various HP products. These resources will help you select the specific assistive technology features and products most appropriate for your situation.

- [HP Elite x3–Accessibility Options \(Windows 10 Mobile\)](#)
- [HP PCs–Windows 7 Accessibility Options](#)
- [HP PCs–Windows 8 Accessibility Options](#)
- [HP PC's–Windows 10 Accessibility Options](#)
- [HP Slate 7 Tablets–Enabling Accessibility Features on Your HP Tablet \(Android 4.1/Jelly Bean\)](#)
- [HP SlateBook PCs–Enabling Accessibility Features \(Android 4.3,4.2/Jelly Bean\)](#)
- [HP Chromebook PCs–Enabling Accessibility Features on Your HP Chromebook or Chromebox \(Chrome OS\)](#)
- [HP Shopping–peripherals for HP products](#)

If you need additional support with the accessibility features on your HP product, see [Contacting support on page 34](#).

Additional links to external partners and suppliers that may provide additional assistance:

- [Microsoft Accessibility information \(Windows 7, Windows 8, Windows 10, Microsoft Office\)](#)
- [Google Products accessibility information \(Android, Chrome, Google Apps\)](#)
- [Assistive Technologies sorted by impairment type](#)
- [Assistive Technology Industry Association \(ATIA\)](#)

Standards and legislation

Countries worldwide are enacting regulations to improve access to products and services for persons with disabilities. These regulations are historically applicable to telecommunications products and services, PCs and printers with certain communications and video playback features, their associated user documentation, and their customer support.

Standards

The US Access Board created Section 508 of the Federal Acquisition Regulation (FAR) standards to address access to information and communication technology (ICT) for people with physical, sensory, or cognitive disabilities.

The standards contain technical criteria specific to various types of technologies, as well as performance-based requirements which focus on functional capabilities of covered products. Specific criteria cover software applications and operating systems, web-based information and applications, computers, telecommunications products, video and multimedia, and self-contained closed products.

Mandate 376 – EN 301 549

The European Union created the EN 301 549 standard within Mandate 376 as an online toolkit for public procurement of ICT products. The standard specifies the accessibility requirements applicable to ICT products and services, with a description of the test procedures and evaluation methodology for each requirement.

Web Content Accessibility Guidelines (WCAG)

Web Content Accessibility Guidelines (WCAG) from the W3C's Web Accessibility Initiative (WAI) helps web designers and developers create sites that better meet the needs of people with disabilities or age-related limitations.

WCAG advances accessibility across the full range of web content (text, images, audio, and video) and web applications. WCAG can be precisely tested, is easy to understand and use, and allows web developers flexibility for innovation. WCAG 2.0 has also been approved as [ISO/IEC 40500:2012](#).

WCAG specifically addresses barriers to accessing the web experienced by people with visual, auditory, physical, cognitive, and neurological disabilities, and by older web users with accessibility needs. WCAG 2.0 provides characteristics of accessible content:

- **Perceivable** (for instance, by addressing text alternatives for images, captions for audio, adaptability of presentation, and color contrast)
- **Operable** (by addressing keyboard access, color contrast, timing of input, seizure avoidance, and navigability)

- **Understandable** (by addressing readability, predictability, and input assistance)
- **Robust** (for instance, by addressing compatibility with assistive technologies)

Legislation and regulations

Accessibility of IT and information has become an area of increasing legislative importance. These links provide information about key legislation, regulations, and standards.

- [United States](#)
- [Canada](#)
- [Europe](#)
- [Australia](#)
- [Worldwide](#)

Useful accessibility resources and links

These organizations, institutions, and resources might be good sources of information about disabilities and age-related limitations.



NOTE: This is not an exhaustive list. These organizations are provided for informational purposes only. HP assumes no responsibility for information or contacts you encounter on the Internet. Listing on this page does not imply endorsement by HP.

Organizations

These organizations are a few of the many that provide information about disabilities and age-related limitations.

- American Association of People with Disabilities (AAPD)
- The Association of Assistive Technology Act Programs (ATAP)
- Hearing Loss Association of America (HLAA)
- Information Technology Technical Assistance and Training Center (ITTATC)
- Lighthouse International
- National Association of the Deaf
- National Federation of the Blind
- Rehabilitation Engineering & Assistive Technology Society of North America (RESNA)
- Telecommunications for the Deaf and Hard of Hearing, Inc. (TDI)
- W3C Web Accessibility Initiative (WAI)

Educational institutions

Many educational institutions, including these examples, provide information about disabilities and age-related limitations.

- California State University, Northridge, Center on Disabilities (CSUN)
- University of Wisconsin - Madison, Trace Center
- University of Minnesota computer accommodations program

Other disability resources

Many resources, including these examples, provide information about disabilities and age-related limitations.

- ADA (Americans with Disabilities Act) Technical Assistance Program
- ILO Global Business and Disability network
- EnableMart
- European Disability Forum
- Job Accommodation Network
- Microsoft Enable

HP links

These HP-specific links provide information that relates to disabilities and age-related limitations.

[Our contact webform](#)

[HP comfort and safety guide](#)

[HP public sector sales](#)

Contacting support

HP offers technical support and assistance with accessibility options for customers with disabilities.



NOTE: Support is in English only.

- Customers who are deaf or hard of hearing who have questions about technical support or accessibility of HP products:
 - Use TRS/VRS/WebCapTel to call (877) 656-7058 Monday through Friday, 6 a.m. to 9 p.m. Mountain Time.
- Customers with other disabilities or age-related limitations who have questions about technical support or accessibility of HP products, choose one of the following options:
 - Call (888) 259-5707 Monday through Friday, 6 a.m. to 9 p.m. Mountain Time.
 - Complete the [Contact form for people with disabilities or age-related limitations](#).